



NTSC U/C

PlayStation™

KIDS TO ADULTS



SLUS-00417

Metro-Cross
Baraduke
Dragon Spirit
Pac-Mania
The Legend of Valkyrie

N A M C O M U S E U M™

VOL. 5

namco®

WARNING: READ BEFORE USING YOUR PlayStation™ GAME CONSOLE.

A very small percentage of individuals may experience epileptic seizures when exposed to certain light patterns or flashing lights. Exposure to certain patterns or backgrounds on a television screen or while playing video games, including games played on the PlayStation game console, may induce an epileptic seizure in these individuals. Certain conditions may induce previously undetected epileptic symptoms even in persons who have no history of prior seizures or epilepsy. If you, or anyone in your family, has an epileptic condition, consult your physician prior to playing. If you experience any of the following symptoms while playing a video game – dizziness, altered vision, eye or muscle twitches, loss of awareness, disorientation, any involuntary movement, or convulsions – IMMEDIATELY discontinue use and consult your physician before resuming play.

WARNING TO OWNERS OF PROJECTION TELEVISIONS:

Do not connect your PlayStation game console to a projection TV without first consulting the user manual for your projection TV, unless it is of the LCD type. Otherwise, it may permanently damage your TV screen.

HANDLING YOUR PlayStation DISC:

- This compact disc is intended for use only with the PlayStation game console.
- Do not bend it, crush it or submerge it in liquids.
- Do not leave it in direct sunlight or near a radiator or other source of heat.
- Be sure to take an occasional rest break during extended play.
- Keep this compact disc clean. Always hold the disc by the edges and keep it in its protective case when not in use. Clean the disc with a lint-free, soft, dry cloth, wiping in straight lines from center to outer edge. Never use solvents or abrasive cleaners.

TABLE OF CONTENTS

Entering the Museum	4
Basic Commands Inside the Museum	5
The Gallery	7
The Opera House	7
The Game Room	8
Customize Settings With the Menu Window	9
Metro-Cross	10
BaraDuke	12
Dragon Spirit	14
Pac-Mania	18
The Legend of Valkyrie	19

Set up your PlayStation™ game console according to the instructions in its Instruction Manual. Make sure the power is off before inserting or removing a compact disc. Insert the **Namco Museum™ Volume 5** disc and close the disc cover. Insert game controllers and turn on the PlayStation game console. Follow on-screen instructions to start a game.

Console

Top View

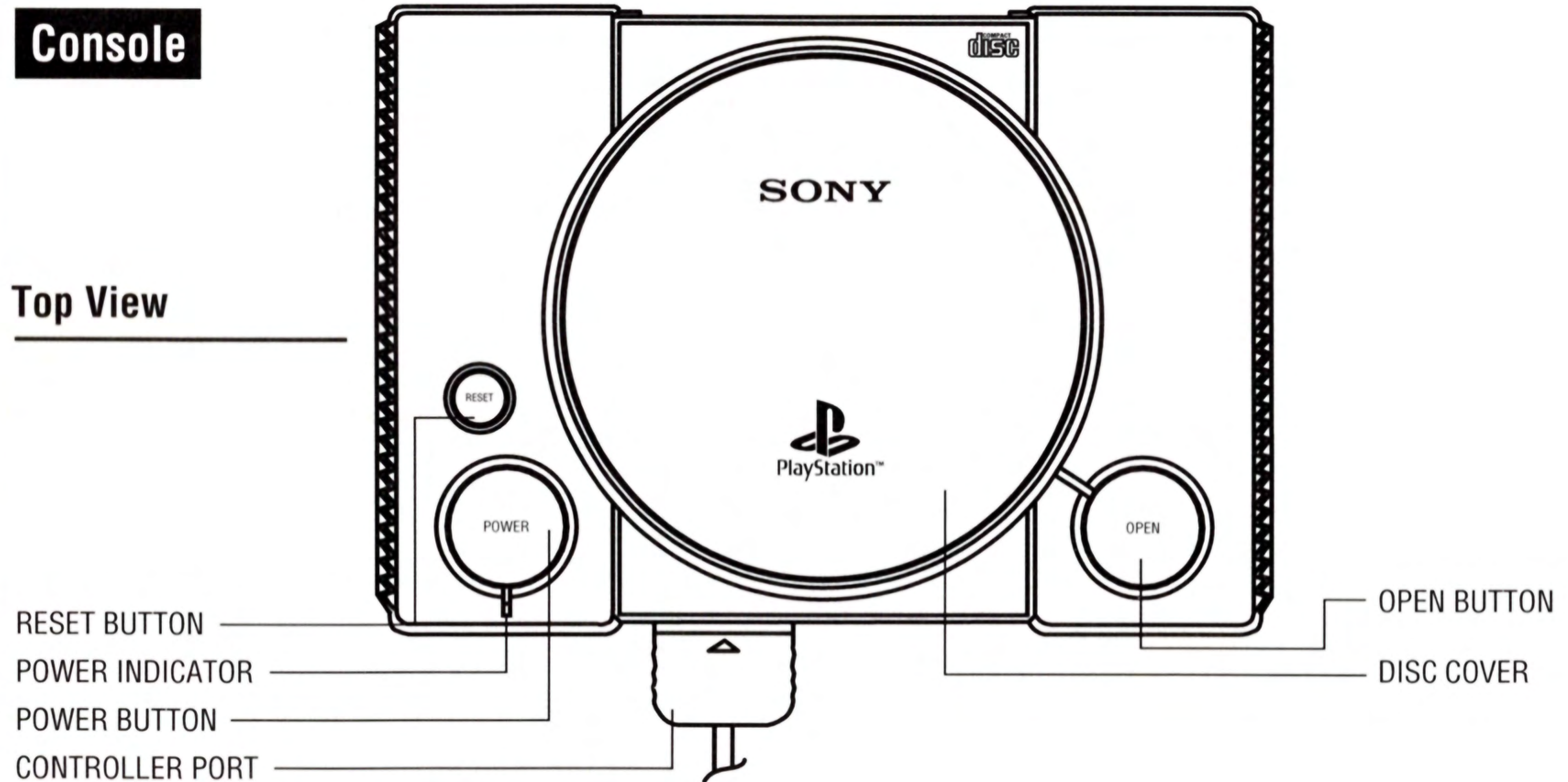

Front View

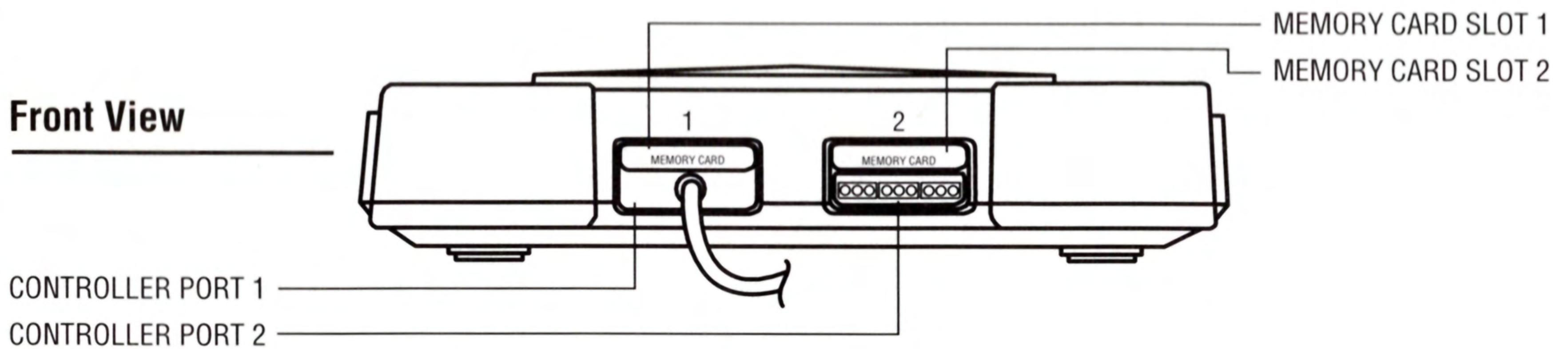

Controller

Front View

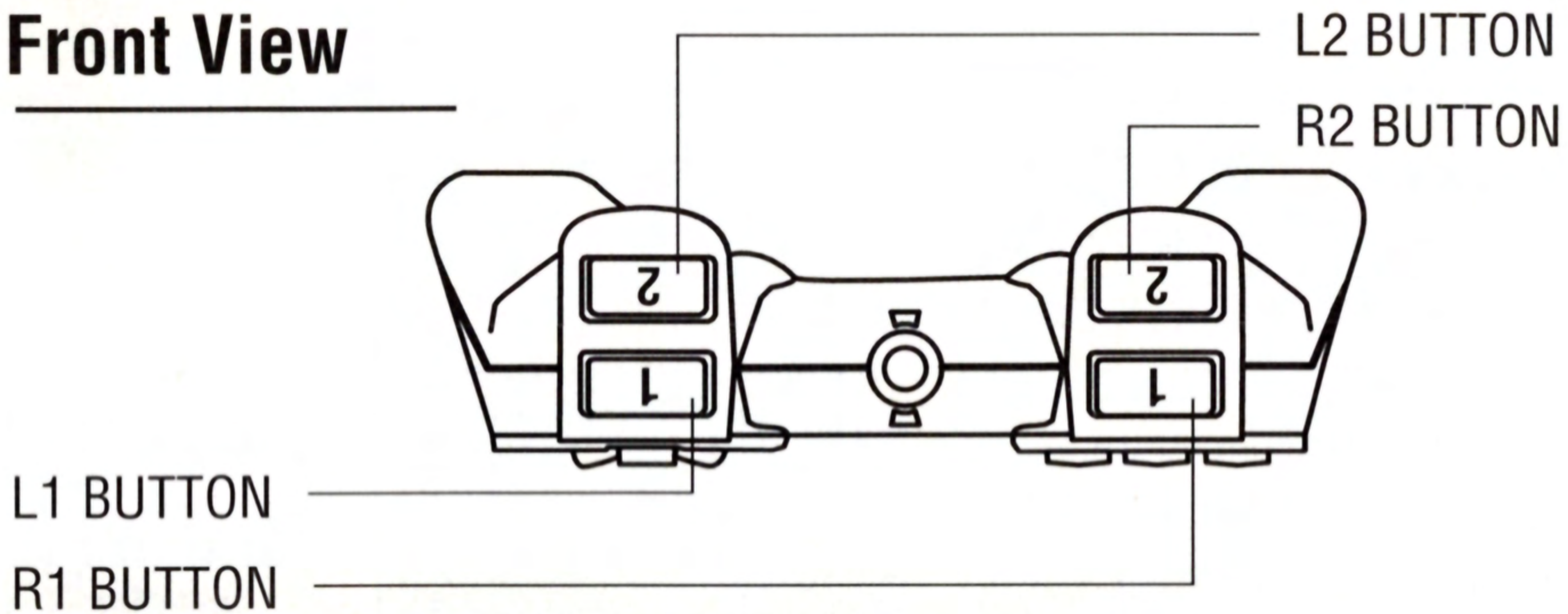

Top View

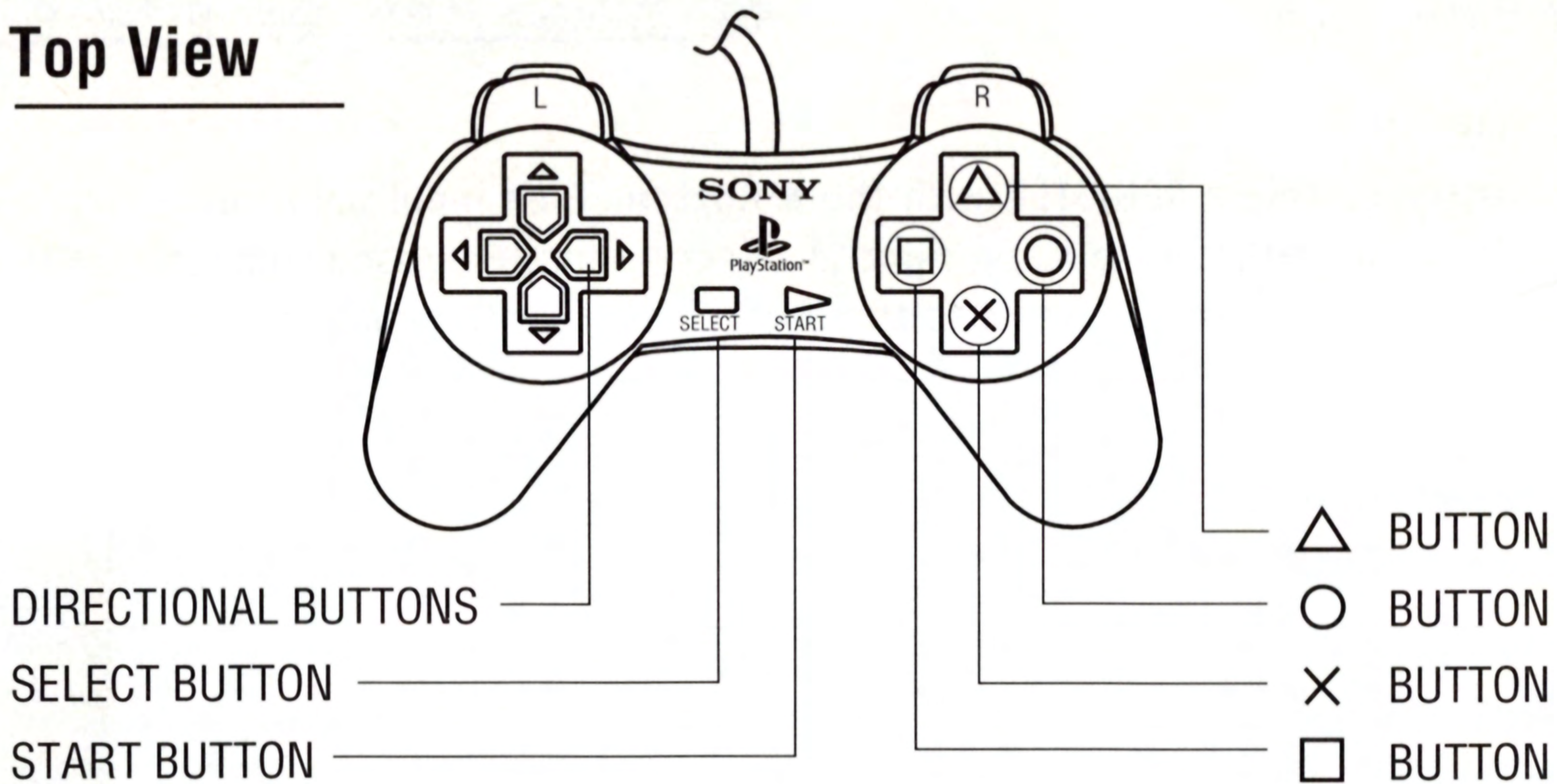

ENTERING THE MUSEUM

GETTING STARTED

When the Title Screen is displayed, press the **Start Button**. When the menu pops up, browse through selections with the **Directional Buttons**, and press either the **X** or **Start Button** to enter your selection.

MUSEUM

Choose this option to enter the Museum, look at exhibits, and play games. When you visit the Museum for the first time, you will want to proceed to the Information Booth.

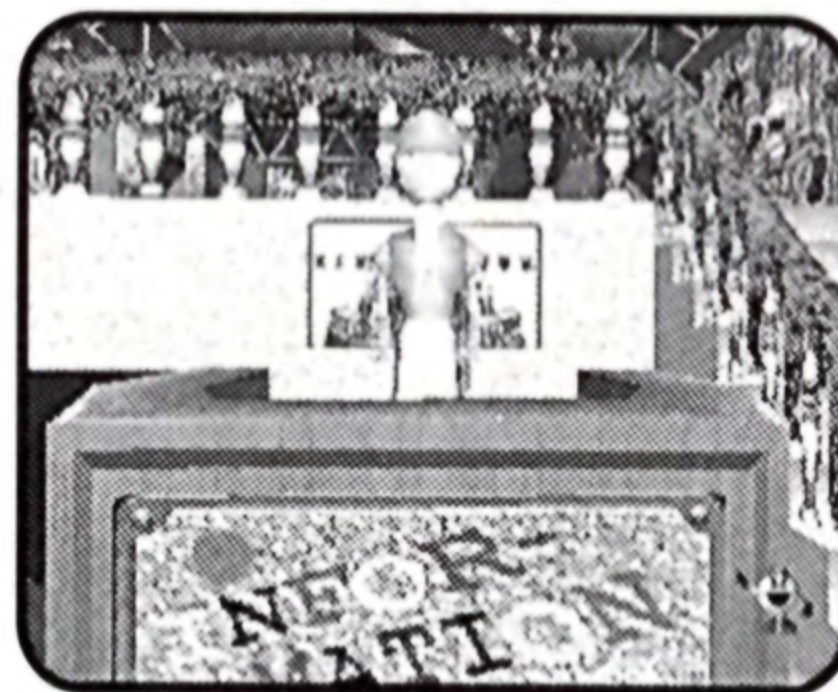

REGISTRATION

On this screen select **REGISTER** with the **X Button**. Then input your initials by moving the **Directional Buttons** left and right to select letters. Enter selected letters with the **X Button**. Your initials can be up to three letters long, with a maximum of five entries.

Note: The memory card, which is sold separately, is necessary for saving games, records, and information.

GAMES

From the Menu, you can play individual games without walking through the Museum. This can be done by selecting **GAMES** and pressing the **X Button**. You can also do this at any time while in the Museum by pressing the **Start Button** to enter the Menu.



STEREO / MONO

Select STEREO or MONO by using the **X Button**.

MAKING SCREEN ADJUSTMENTS

Adjust the position of the screen by using the **Directional Buttons**. When you are finished, return to the Title Screen by using the **Start Button**.

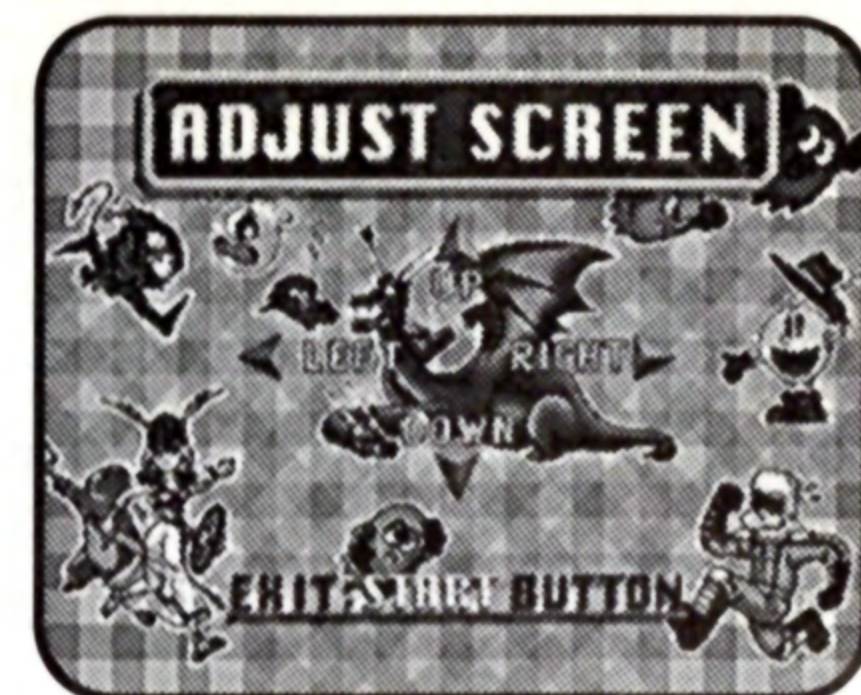

BASIC COMMANDS INSIDE THE MUSEUM

The commands used inside the Museum are explained below. Please read the explanation of the game controller provided on the pages relating to the respective games.

STANDARD CONTROLLER

BUTTON	ACTION
Start Button	Use to open or close the Game Menu. Also use to leave the Information Booth.
Directional Buttons	Move forward and backward with the Up / Down Buttons . Use the Left / Right Buttons to change the direction you're facing. Also use to move through selections in menus.
L1/R1 Buttons	Use to move Left or Right.
▲ Button	Use to look upward.
X Button	Use to view museum items or to enter Menu selections.
● Button	Press and hold this button while moving forward or backward to speed up.
■ Button	Use when looking upward to return to normal view.

The Pac-Man in the lower right hand corner of the screen is the Museum Guide. He will move when you approach a display, which you can then view using the **X Button**. An explanation of the item will appear. You can also view items other than displays, so be sure to check around various places within the museum.

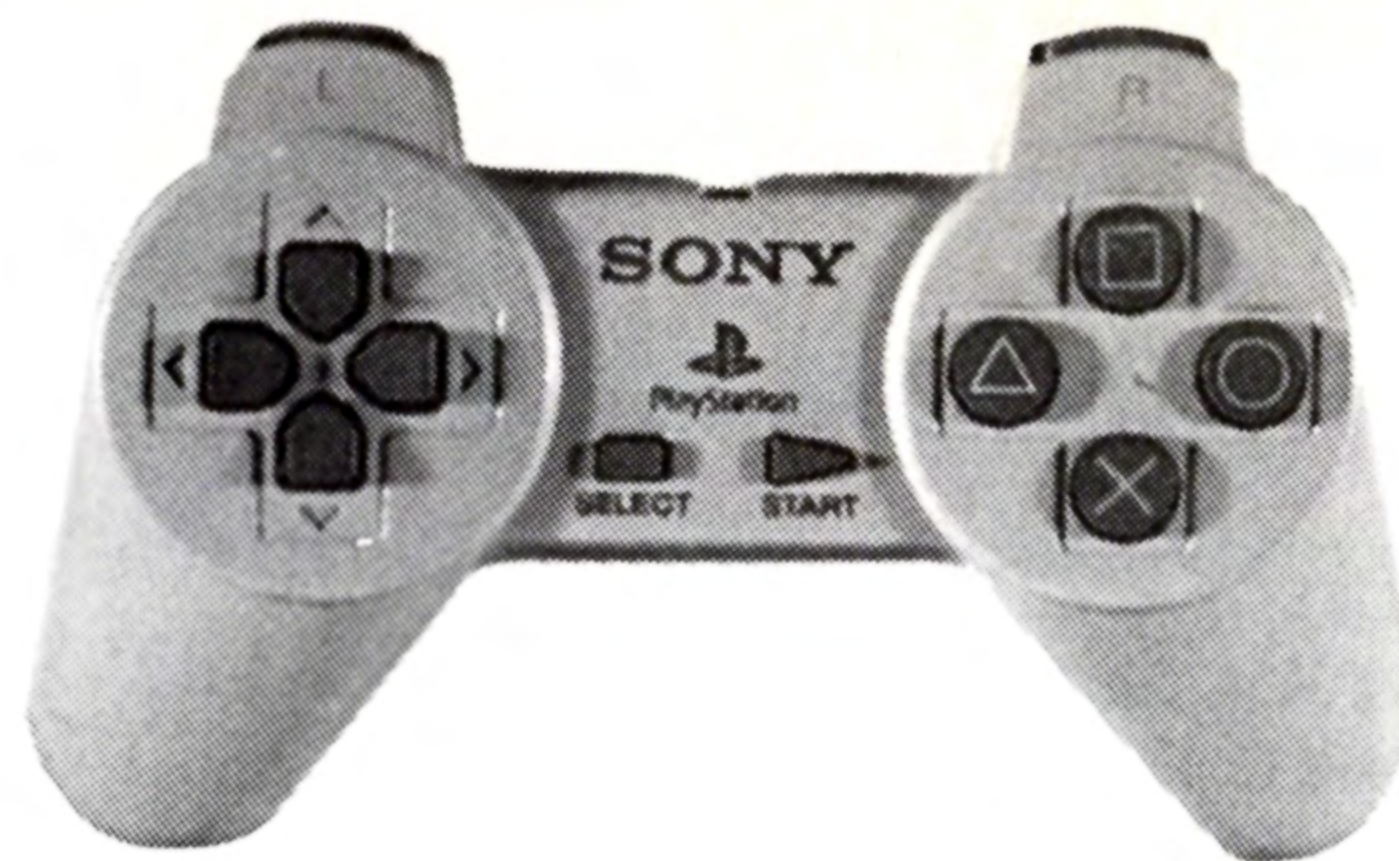

INFORMATION

At the reception area, you can view explanations of the various rooms. You can also enter or change players' names here. Toggle through the Menu with the **Directional Buttons**, and input your selection with the **X Button**. Regarding registering user names, please see the Museum Registration on page 4. To delete names, just select **Delete** in the name registry. Choose **Exit** to return to the Museum Screen.

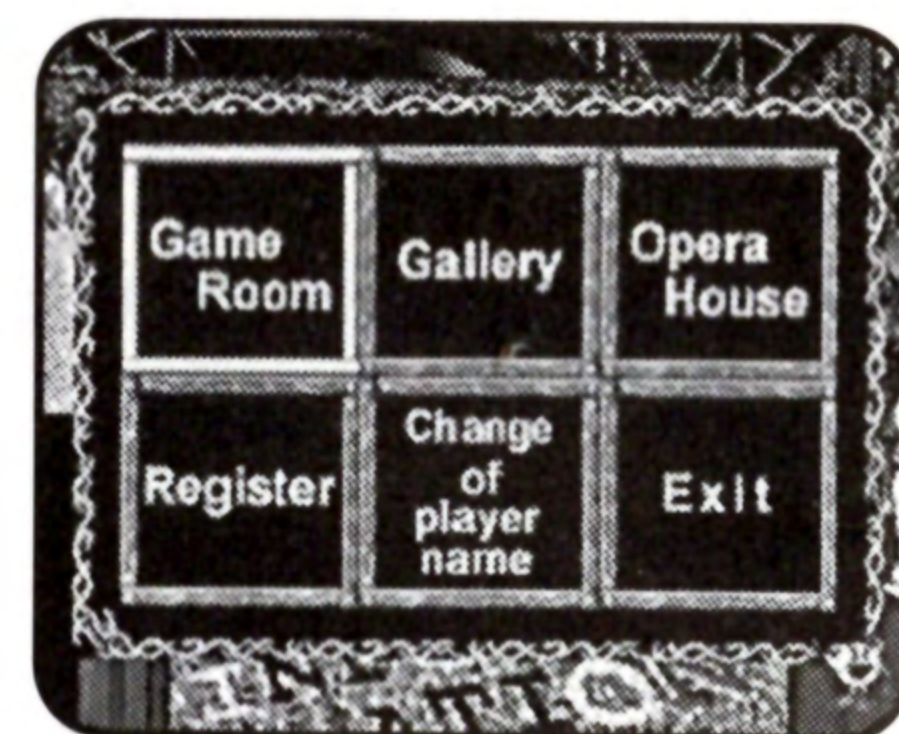

ELEVATOR

Use the elevator to go to the roof where you can visit the Gallery, the Opera House, or the Data Note.

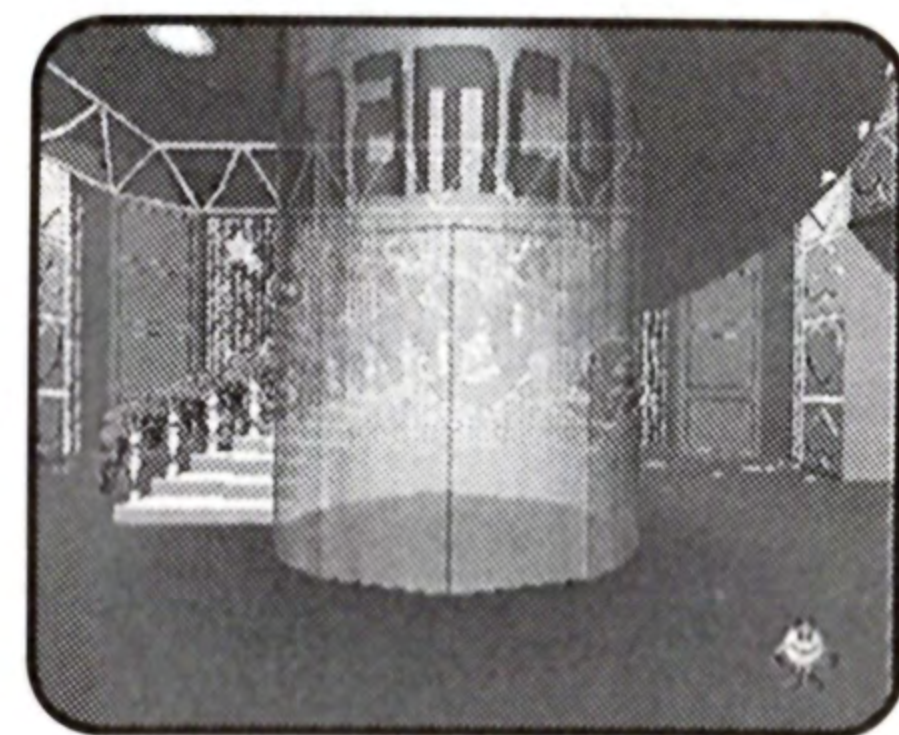

DATA NOTE

Here you can view top scores and other misc. information. Use the **Up** and **Down Directional Buttons** to move through the menus, and toggle with the **Left** and **Right Directional Buttons**. Use the **Start Button** to return to the Museum Screen.

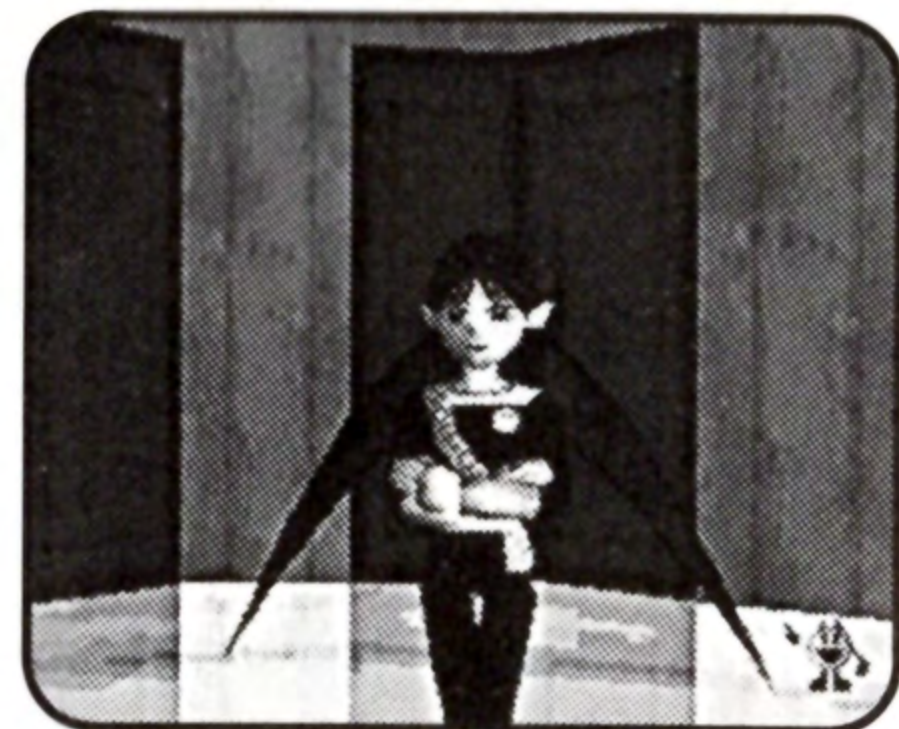

THE GALLERY

When you get to a display you want to view, push the **X Button** for a closer look. Use the following buttons to manipulate your view of the display (The following will be displayed in the lower-right portion of the screen, but may be difficult to see when the display is dark):



VIEW OPTIONS (FOR DESIGNATED DISPLAYS ONLY)

BUTTON	ACTION
Directional Buttons	Use to switch among displays or for scrolling.
X Button	Use to enlarge the display screen and to zoom in.
● Button	Use to zoom out.
L1 or R1 Buttons	Use to flip pages (for some displays only).
▲ Button	Use to bring up or close the button prompt menu.
Start Button	Use to end viewing.

THE OPERA HOUSE

At the Opera House, you can enjoy all of the visual and sound effects from the games. When you are near the stage, pushing the **X Button** will display icons, which you can then toggle through by using the **Left** and **Right Directional Buttons**. Press the **X Button** again to enter your selection and the slide show screen will appear.



SLIDE SHOW OPTIONS

BUTTON	ACTION
Directional Buttons	Use the Up / Down Buttons to choose different games, and the Left / Right Buttons to choose different songs.
X Button	Play selection.
● Button	End selection.
Start Button	End viewing session.

THE GAME ROOM

PLAYING THE GAMES

Press the **X Button** in front of a game machine to play it. Use the **Directional Buttons** to choose among the registered users, and enter your selection by pressing the **X Button** again. (If there is only one user registered, the game will automatically skip this step).

On the Title Screen, insert a credit into the game machine with the **Start Button**, then press the **Start Button** again to begin play. For a two-player game, increase the Credits to two by pressing Player #2's **Start Button** twice. You can also use the player's **Select Button** to enter additional credits.

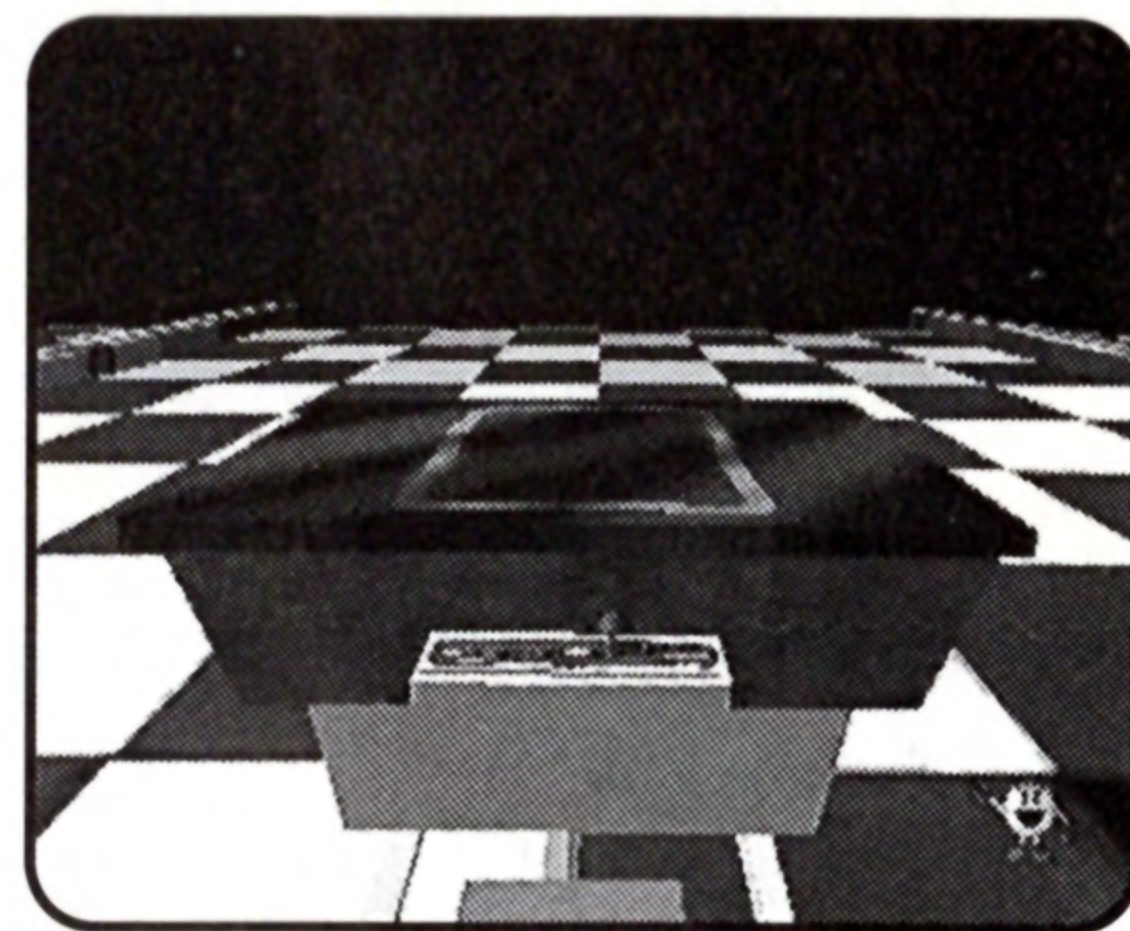

NOTES:

- The nonsense characters that flow across the screen before the game begins are merely a reproduction of what happened on the original arcade games when they were plugged in. Your game player is NOT malfunctioning.
- Player #2's controller is necessary for two-player games.

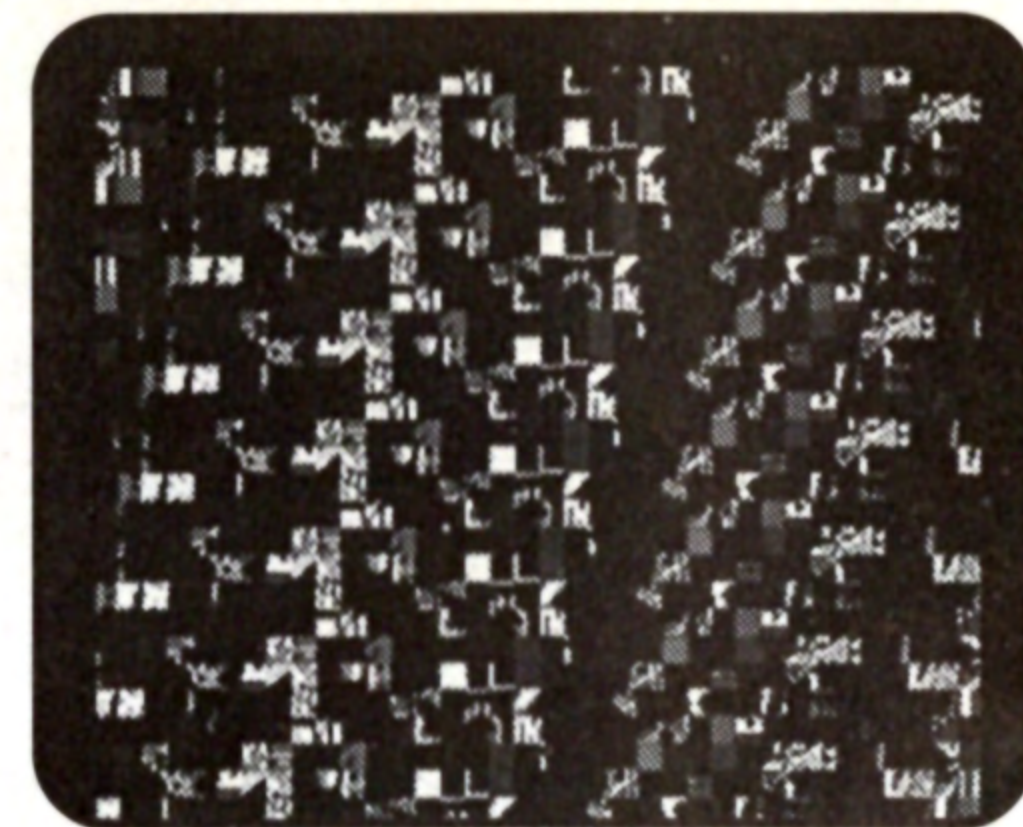

CUSTOMIZE SETTINGS WITH THE MENU WINDOW

On the Title Screen, the Test Screen, or in the middle of a paused game, pressing the **▲ Button** will bring up a menu which you can use to end the game you're playing or to customize game settings. Make your selections with the **Directional Buttons** and enter your selection with the **X Button** or cancel with the **● Button**. Even within the same game, the menu may differ depending on when it is called up. To exit this menu quickly, press the **▲ Button**.

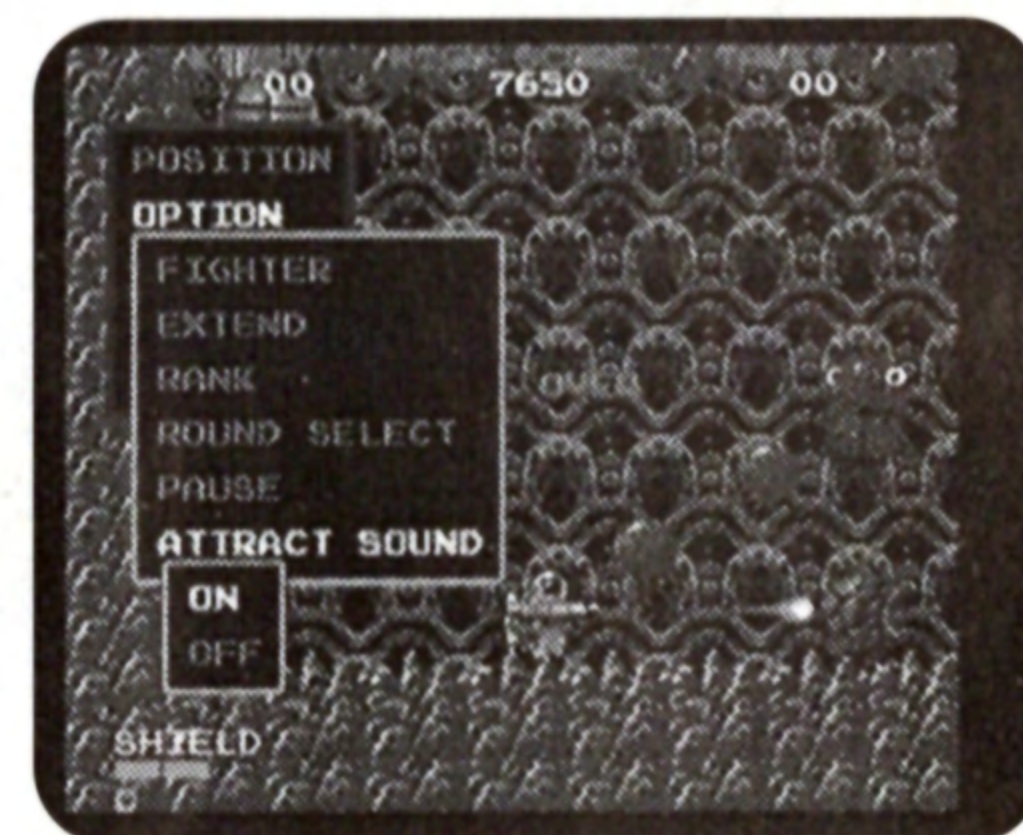
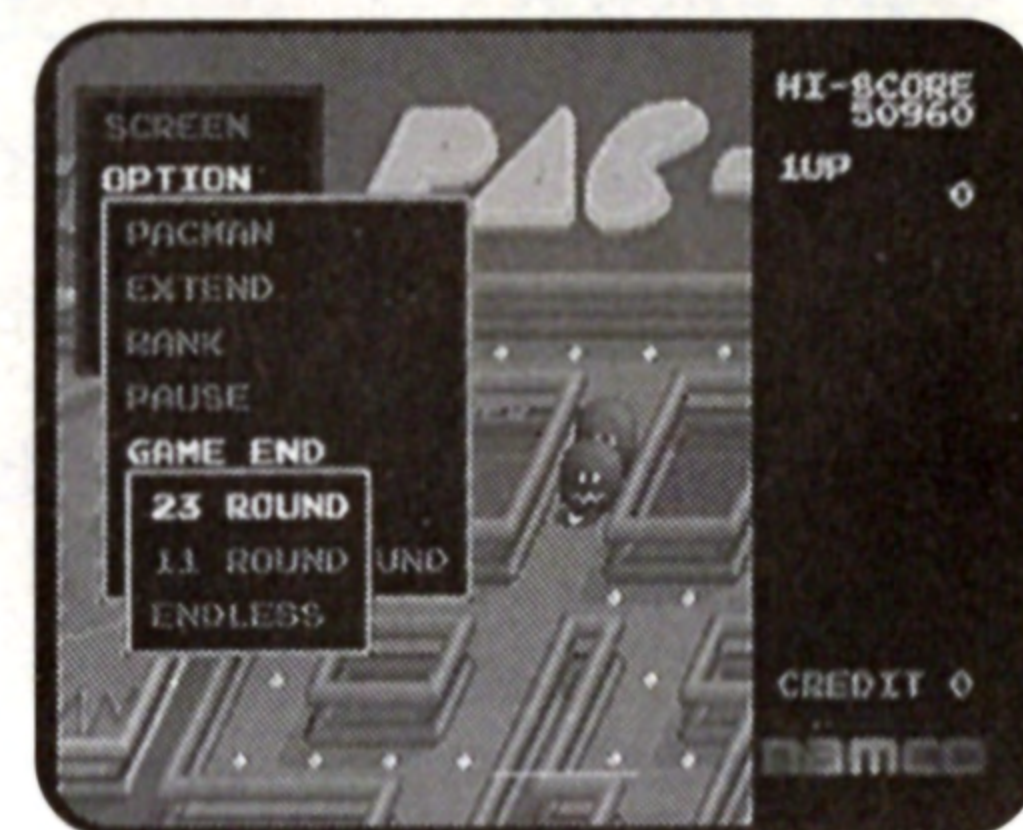

METRO-CROSS

USING THE STANDARD CONTROLLER

BUTTON	ACTION
X Button	Jump or enter new selections.
Directional Buttons	Use to move around or for menu selections.
Select Button	Insert Credits.
Start Button	Start or Pause a game.
▲ Button	Press on the Title Screen, the Test Screen, or when a game is paused to call up a menu.
● Button	Use to jump or close a menu.

MAIN SCREEN

1. Score
2. High Score
3. Round Number
4. Area Gauge

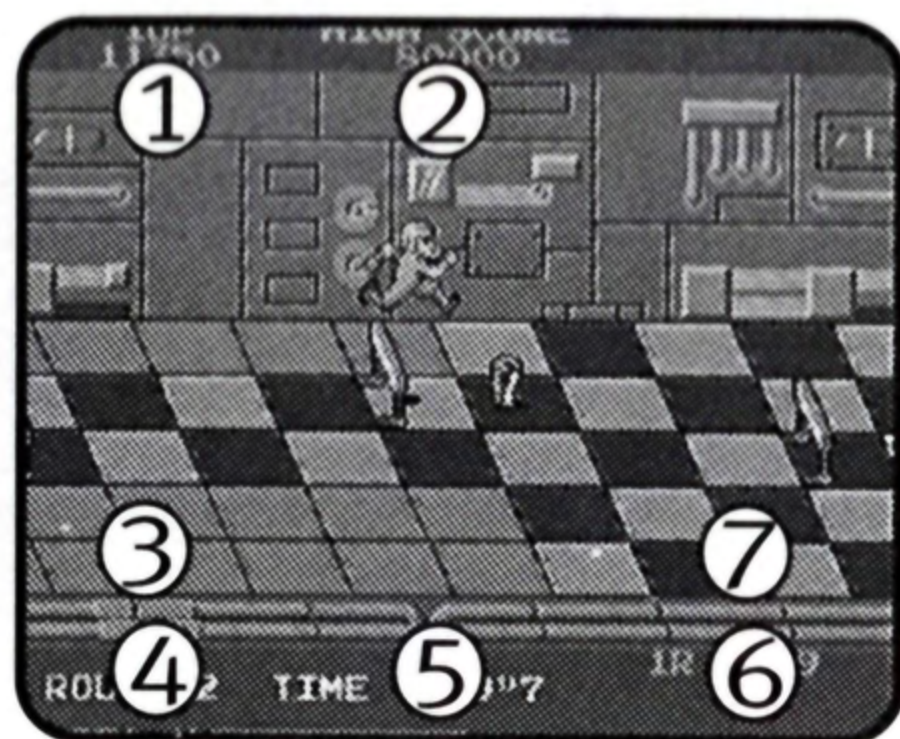

5. Time Remaining
6. Credits
7. Area Clear Time

How to Play

Your character can run, jump and ride skateboards. There are numerous obstacles between you and the goal — all you have to do is avoid them, run for all you're worth, and get to the goal before time runs out.

Success depends on how well you can use the items you find in the area. Kick the cans again and again to boost your score, or step on them to temporarily stop the time. Grab the Special Drinks, and you will speed up temporarily.

Cans can be used to either boost your score or stop time. Choose wisely.

1. Watch out for Rats! The green rats give bites that can slow you down. If they swarm around you, shake them off by moving the **Left** and **Right Directional Buttons** back and forth quickly.
2. Speed up with the Skateboard: When you're on the skateboard, the green tiles will not slow you down. Avoid obstacles since colliding with one will knock you off the board. Slalom around every obstacle that crosses your path, and grab a Special Drink to speed up even more!
3. Take a Shortcut with Ramps: You'll see the Ramps in some levels. Just hold down the **X** or **● Buttons** while going over the ramp to jump, and up, up, and away you go! Use the **Left** and **Right Directional Buttons** while in the air to control where you land.

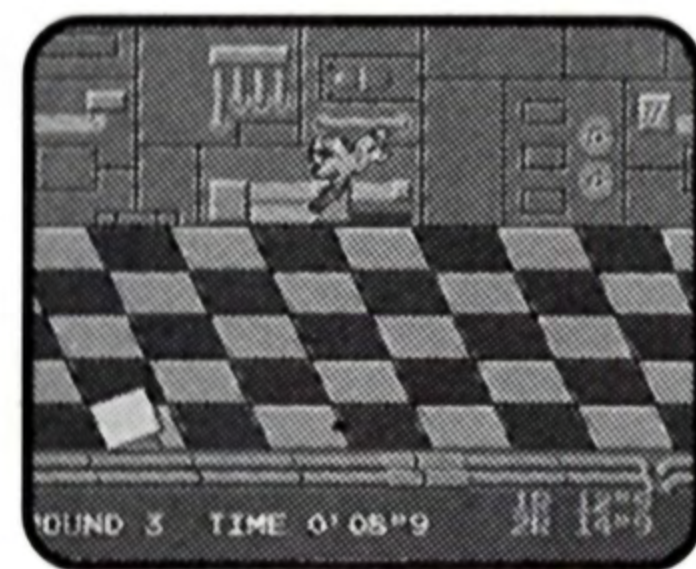
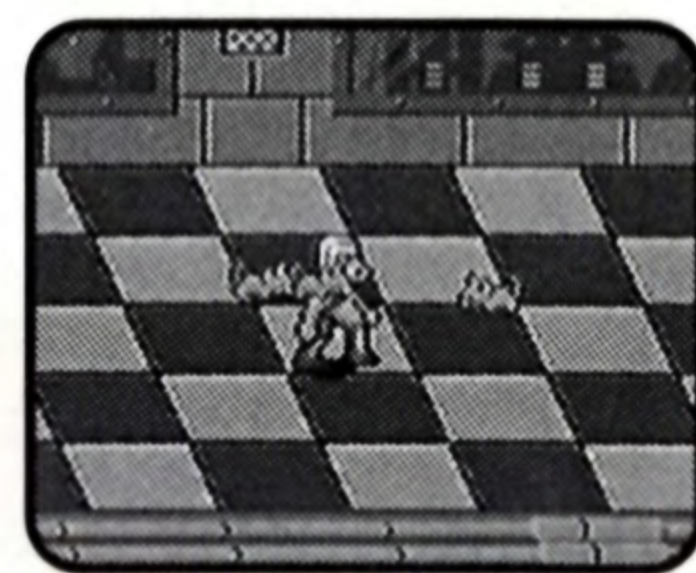

THE WIZARD

USING THE STANDARD CONTROLLER

BUTTON

ACTION

Directional Buttons

Use to move around or for menu selections.

Select Button

Insert Credits.

Start Button

Start or Pause game.

▲ Button

Press on the Title Screen, the Test Screen, or when a game is paused to call up a menu.

X Button

Use to shoot or to enter menu selections.

● Button

Use to shoot or to close a menu.

MAIN SCREEN

1. Score
2. High Score
3. Shields

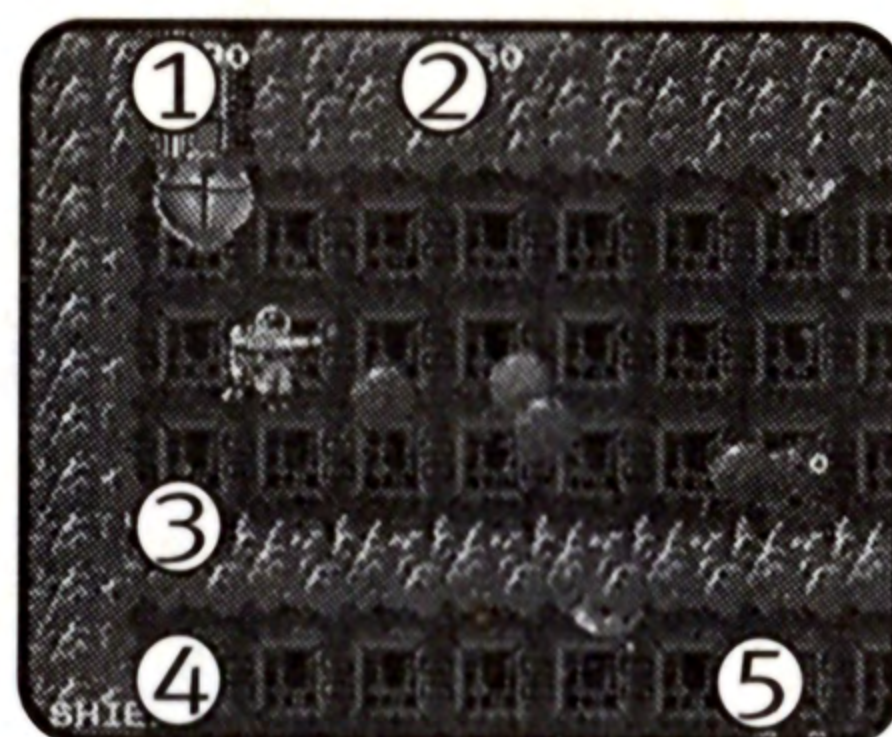

4. Number of Pakets
5. Fighters Remaining

How to Play

The Pakets, a peaceful people, have been invaded and persecuted by the nasty Octi clan. Having received their SOS signal, the frontier defense force has decided to send you, their best fighter pilot, to rescue the Pakets. Your mission is to infiltrate and destroy the underground fortress of the super-powerful Octis.

1. Your fighter comes equipped with shields. If you are hit by the enemy shots or are rammed by an enemy, you will use up your shield. If you are hit without shields, you will lose your fighter. The game is over when you lose all of your fighters.
2. When you eliminate all the Octis on a floor, a gate will open to take you to the next floor (a GATE OPEN sign will be displayed on the screen). When you clear a floor with three or more shields remaining, and/or have saved one or more Pakets, you will enter a bonus round.
3. You receive new fighters at certain score levels.



USING THE STANDARD CONTROLLER

BUTTON	ACTION
Select Button	Insert Credits.
Directional Buttons	Use to move around or for menu selections.
Start Button	Start or pause game.
● Button	Use to shoot Dragon-fire at enemies in the air or to close menu.
▲ Button	Press on the Title Screen, the Test Screen, or when a game is paused to call up menu.
X Button	Use to shoot Dragon-fire at enemies on the ground or to enter menu selections.

MAIN SCREEN

1. Score
2. High Score
3. Life Gauge
4. Fire Gauge

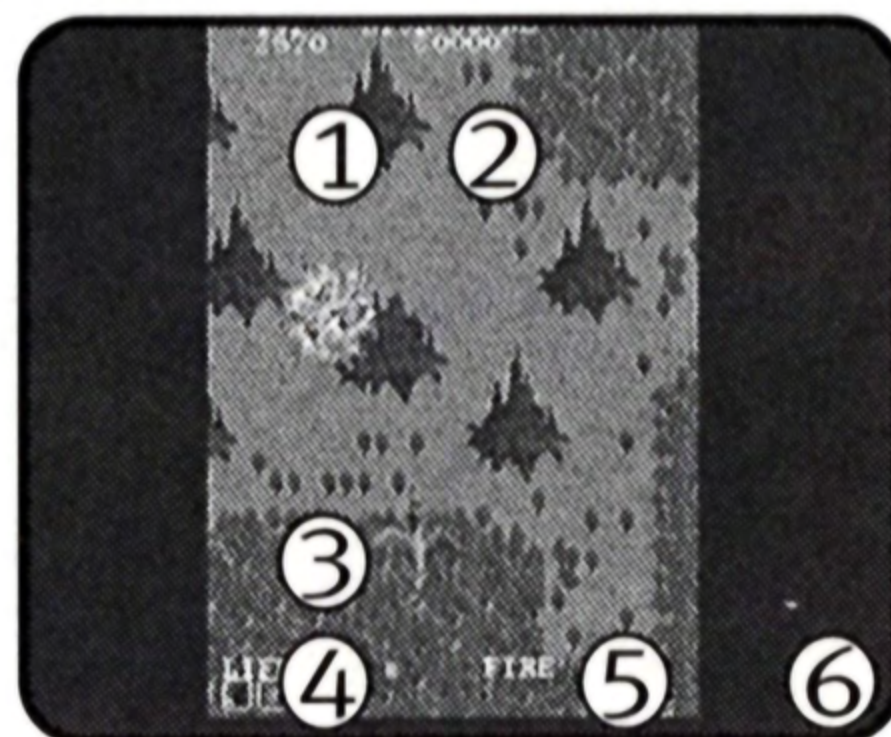

5. Dragons Remaining
6. Area Number

You may choose to play either the OLD or the NEW version of Dragon Spirit; the dragon's speed and the number of its lives make the game easier in the NEW version. Switch between versions in the menu window.

How to Play

Princess Alisha has been spirited away by the King of Darkness Zael to be offered up as a sacrifice. You, the good knight Amur, transform into a the Blue Dragon to save her from her fate.

1. You can select which round in which to start (providing you have set the Round Select option ON in the menu). Move the **Directional Buttons** left and right to choose your round, and press the **X Button** to enter selection.
2. When the Dragon runs into the enemy or is hit by enemy shots, the life gauge will go down (or, if you are powered up, you will then be powered down). When the life gauge reaches zero, one life is lost; when you lose all your lives, the game is over.
3. Enemies will attack you from both ground and air. You can't use Dragon-fire meant for the air against enemies on the ground, and vice versa, so use them skillfully!
4. Zael's underling Bosses appear at the end of each area. When you kill each boss, you clear the area.
5. At a certain score level, or when three extends are collected, you will receive an extra Dragon.

Collect Items to Power Up

When you break the blue or red-colored eggs on the ground, or kill the blinking white enemies, different kinds of power up items will appear. These items can help you clear the area you're in, don't miss them!

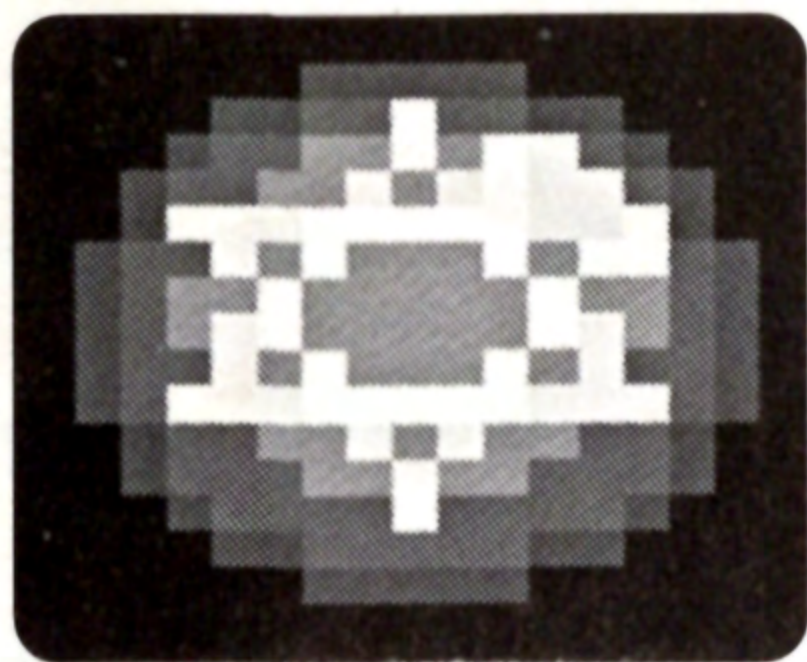

Red Balls -- Fire gauge will increase by one, or when the gauge is at 3, the power of your fire will increase, up to a maximum of two times.

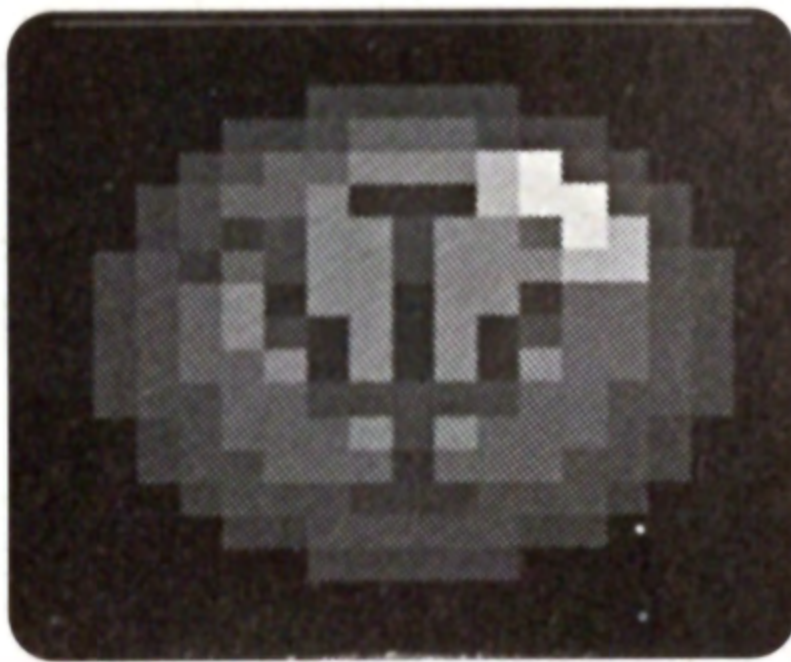

Blue Balls -- The Dragon will sprout more heads, giving you more firepower (maximum of three).

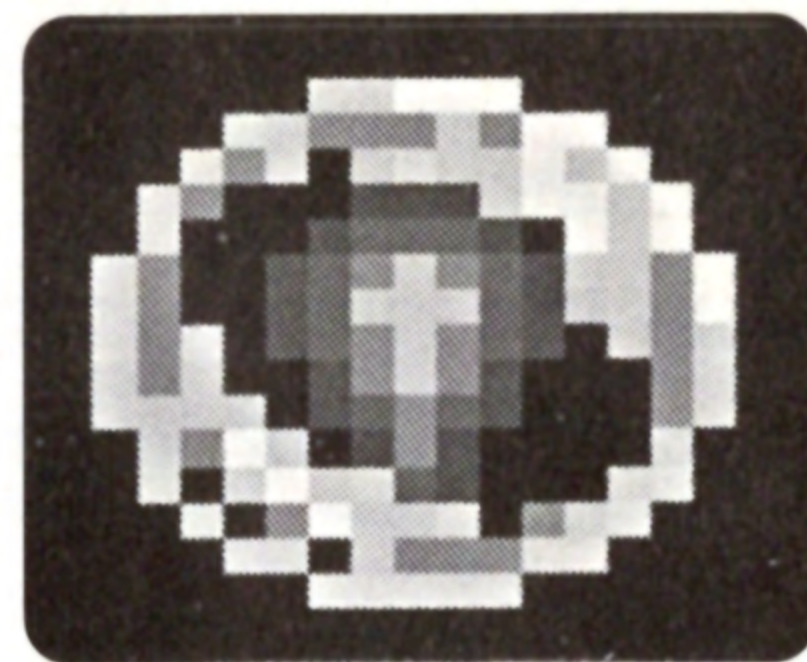

Fire Brace -- Attain 8 times normal firepower against your airborne enemies.



Small Dragon -- Your Dragon's body shrinks, becoming a harder target.

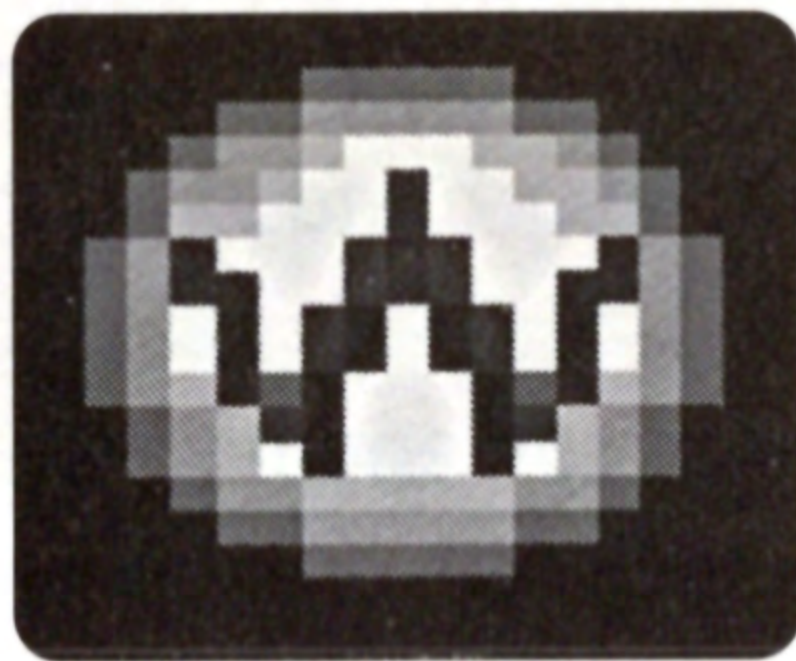

Wide Fire -- Gives your Dragon-fire against airborne enemies a wider spread.

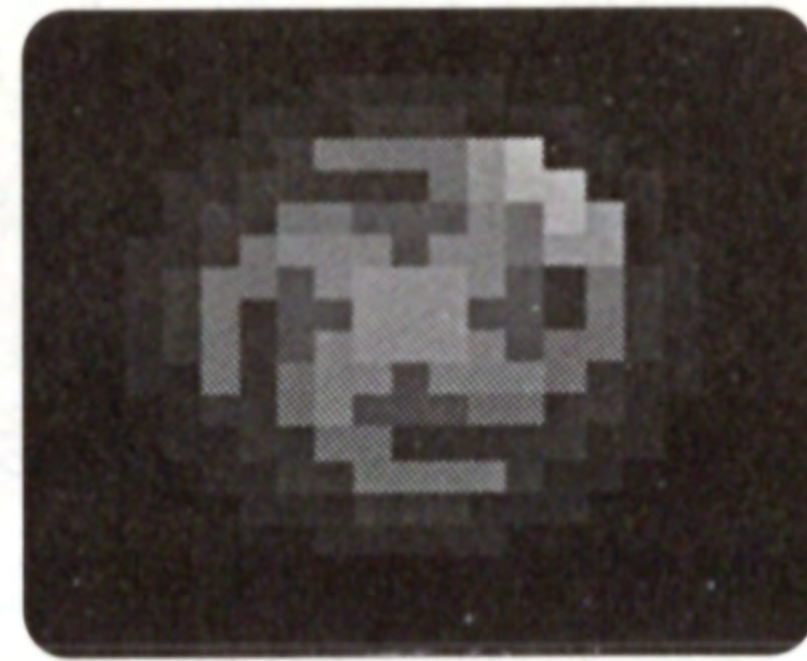

Homing Fire -- For a limited time, your Dragon-fire will home in on enemies.

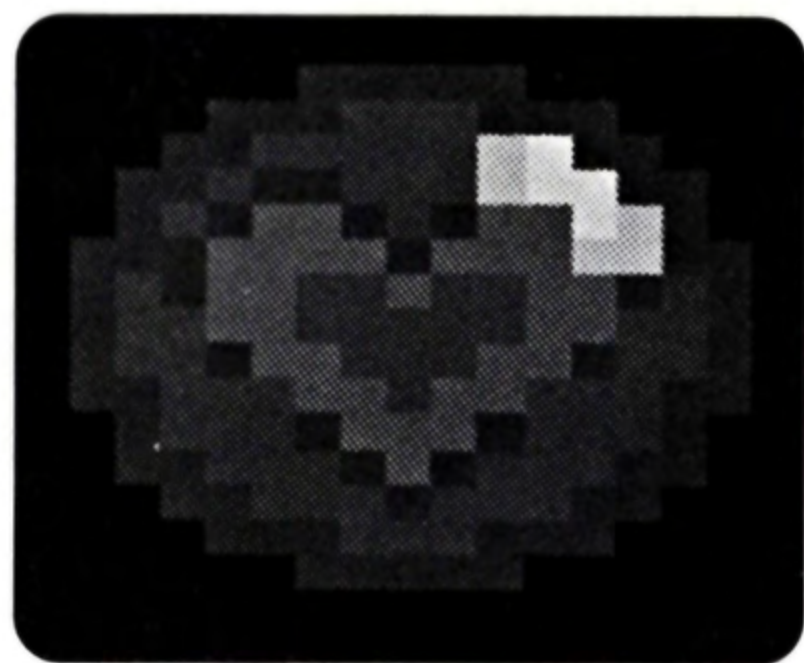

Extend -- Collect three of these and you are rewarded with an extra life.

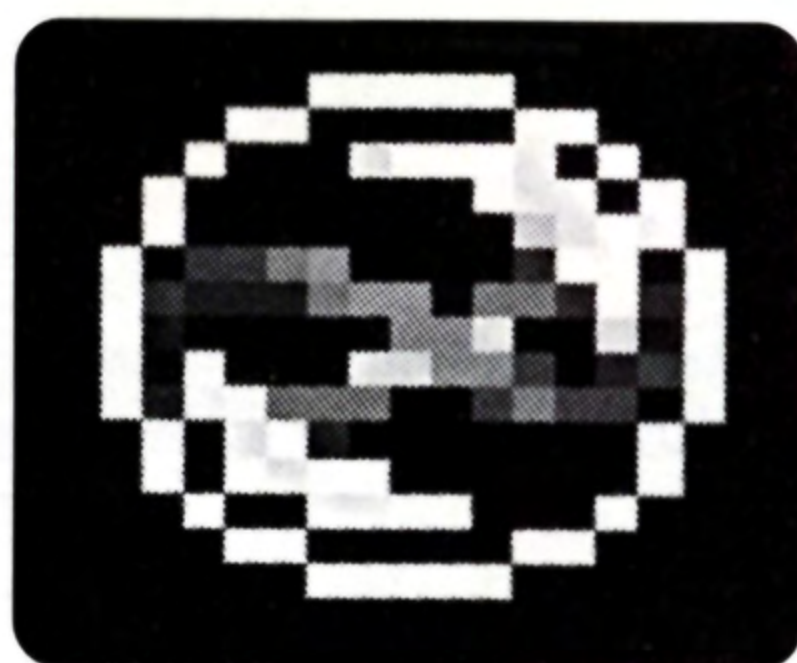

Earthquake -- Causes earthquakes, wreaking destruction on ground enemies.

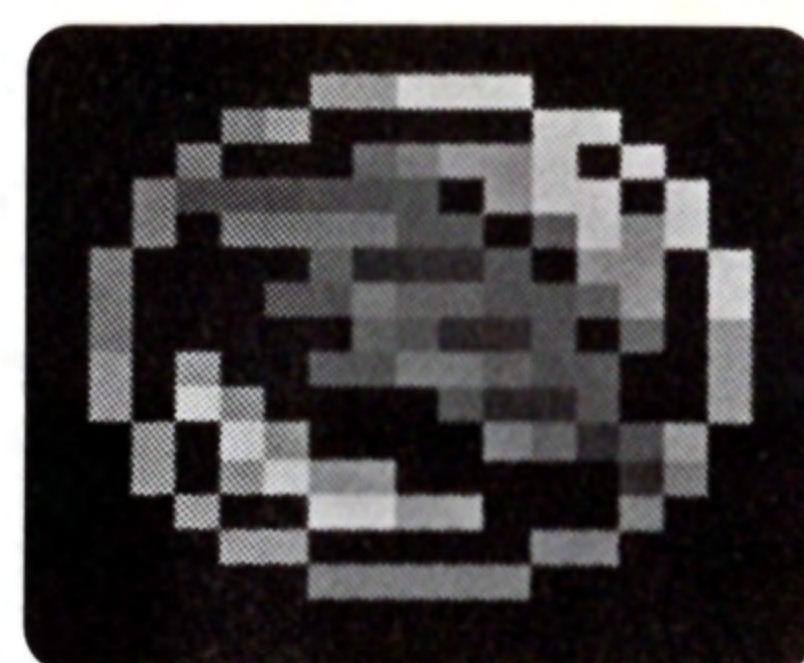

Power-Wing -- Erects barriers to make your Dragon temporarily invincible.



Diamonds -- Receive a bonus of 100 points.

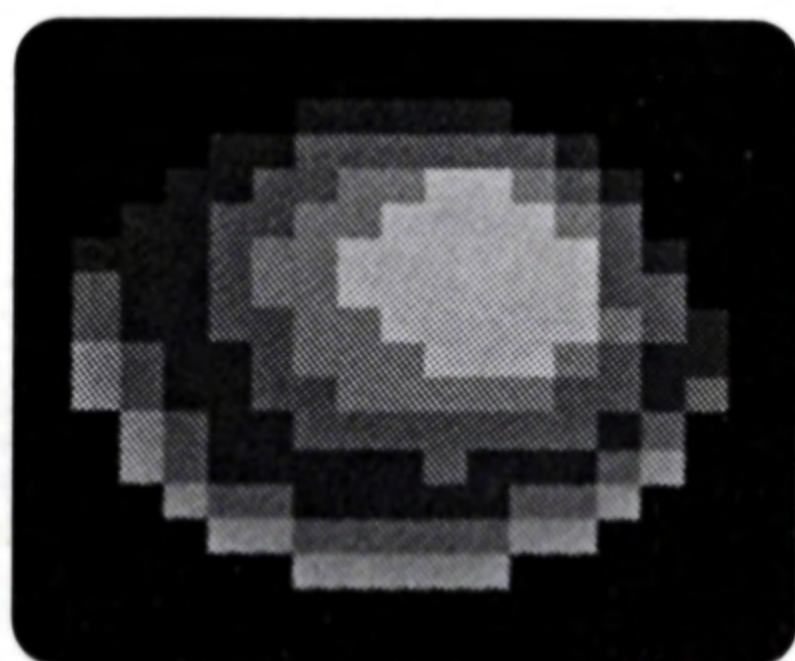

Gold -- Receive a bonus of 10,000 points.



Magic Eye -- In the Dark level, this will let you see more.

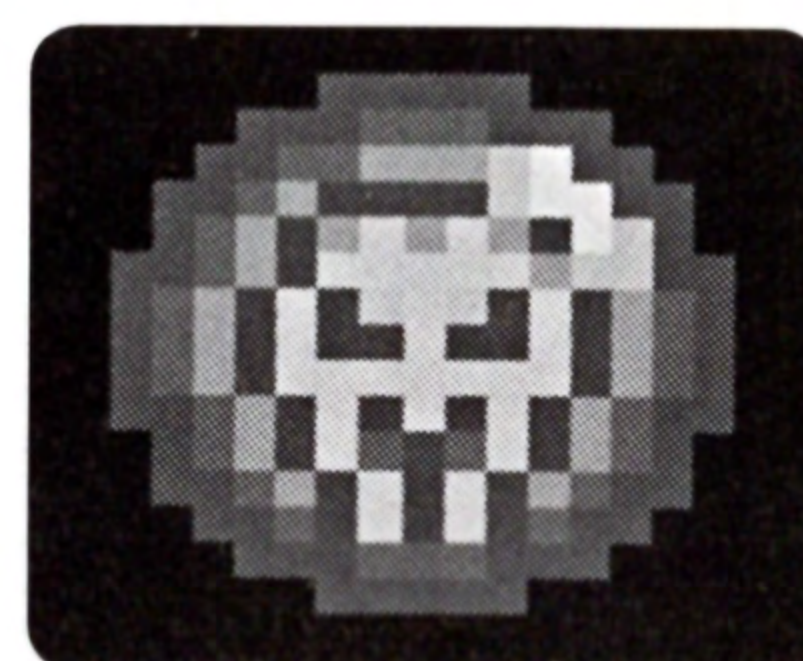

Power Down -- Removes your Power Up status.



USING THE STANDARD CONTROLLER

BUTTON	ACTION
■ Button	Jump.
Directional Buttons	Use to move around or for menu selections.
Select Button	Insert Credits.
Start Button	Start or pause game.
▲ Button	Press on the Title Screen, the Test Screen, or when a game is paused to call up menu.
X Button	Use to jump or enter menu selections.
● Button	Use to jump or to close menu.
MAIN SCREEN	<ol style="list-style-type: none"> 1. Score 2. High Score 3. Lives Remaining 4. Credits 5. Round#

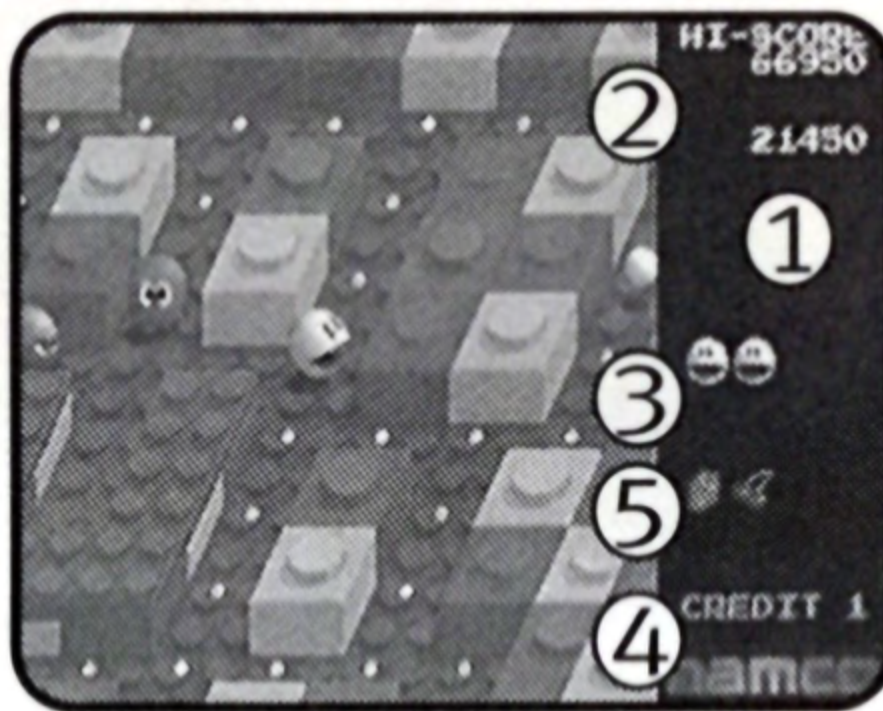

How to Play

Move your Pac-Man around the maze, avoiding ghosts and eating all dots. Munch all the dots, and you clear the round. The secret to winning is wise use of jumping and of the Power Pills.

1. Move your Pac-Man with the **Directional Buttons**; press the **X**, **●**, or **■ Buttons** to jump. You can jump over ghosts, but be careful: there are ghosts out there that can jump too!
2. When your Pac-Man touches a ghost, you lose a life; lose all your lives and the game is over.
3. At a certain score level you will receive an extra life.

THE LEGEND OF "VALKYRIE"

USING THE STANDARD CONTROLLER

BUTTON	ACTION
Start Button	Start or pause game.
Directional Buttons	Use to control movement, select magic, or for menu selections.
Select Button	Insert Credits.
X Button	Use to jump or to open menus.
▲ Button	Press on the Title Screen, the Test Screen, or when a game is paused to call up menu.
■ Button	Use to attack. Hold button down to prepare for magic attack, use Left and Right Directional Buttons to select the magic you want to use, and release button to unleash attack. Also use for entering menu selections.
● Button	Same functions as ■ Button. Also use to close menu.

MAIN SCREEN

1. Lives Remaining
2. Item Held
3. Score
4. Gold
5. Time Remaining

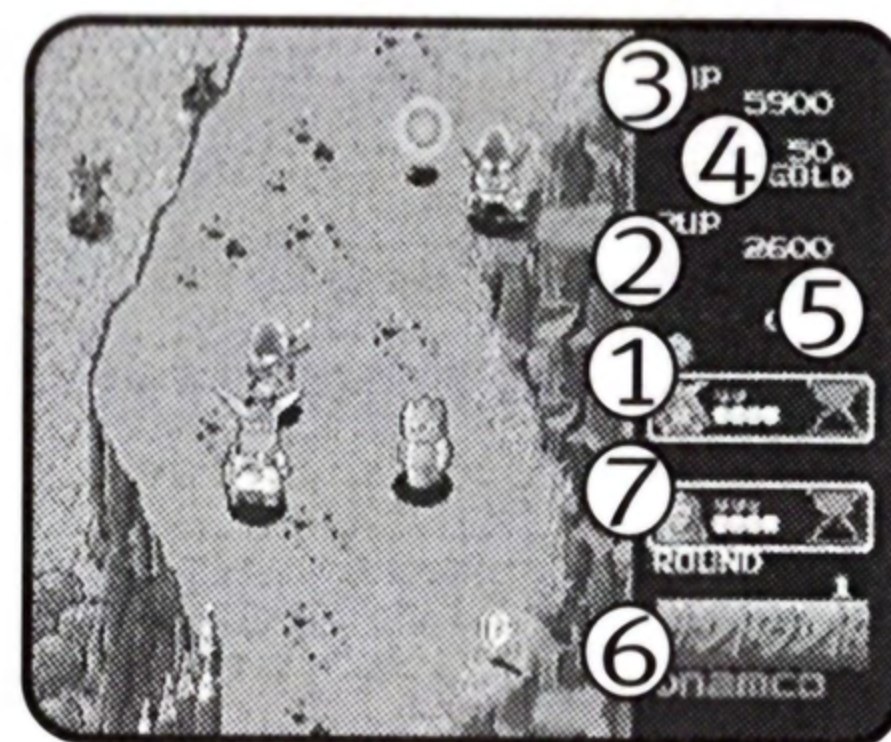

6. Round No.
7. Magic Ball (MP)

How to Play

"The Golden Seed," the symbol of peace and capable of fulfilling any wish, is one day stolen by the evil Kamooz. Peace disappears from the land and nature begins to wither away. As the hearts of the people are corrupted and go astray, Valkyrie, the warrior of love and bravery, appears to save the world.

1. Insert two credits with Player #2's **Start Button** and both players can play simultaneously.
2. When you hit an enemy or fall into a hole, your life level will decrease. When it reaches zero the game is over.
3. When the game ends, Valkyrie becomes an angel and leaves the screen. If you insert another credit and press the **Start Button** before she reaches the screen edge, though, you can start again from where she died. If Valkyrie does go off screen, you will restart from farther back in the round.
4. In a two-player game, if either player dies the game will still go on. If the player who died inserts a credit and presses the **Start Button**, they can begin a new game with their partner.

EARN GOLD AND GO SHOPPING!

Every time you kill an enemy, gold appears. Take this gold and use it to buy items to fight with from Zul's store. In the store, choose the items you want with the **Directional Buttons**, and finalize your purchase with the **X Button**. Press the **X Button** while holding the **Down Directional Button** to exit the store.

You can also find items in jewel-boxes scattered throughout the rounds.

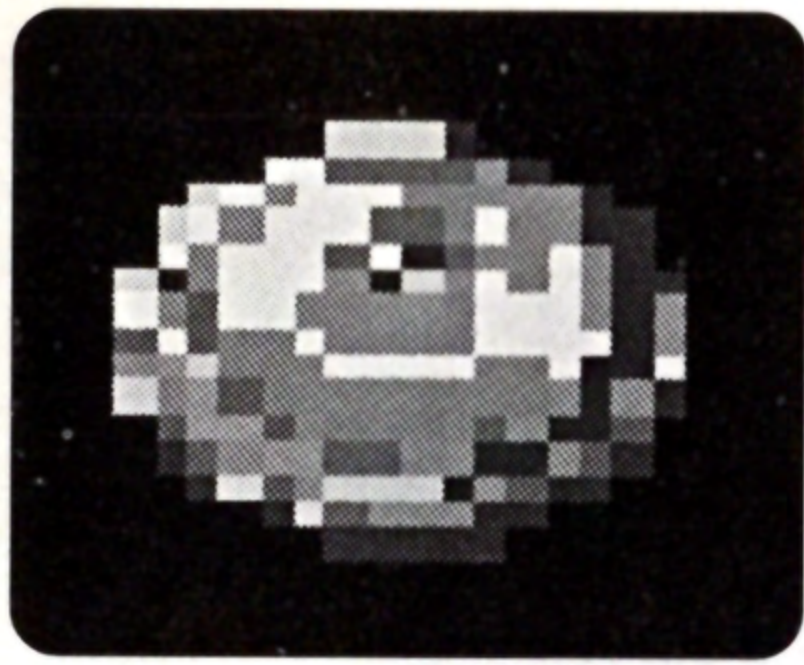

Wide Beam -- A weapon capable of firing scattering shots.

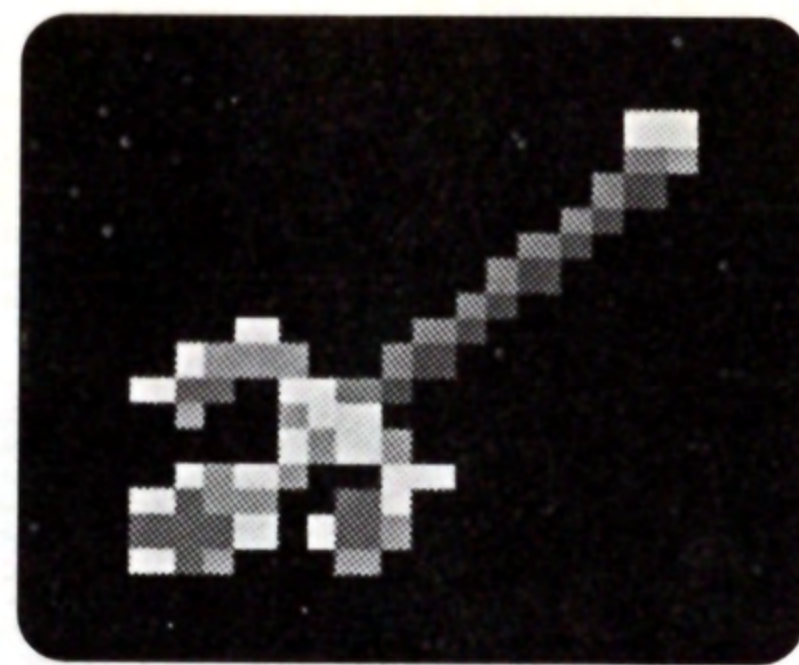

3-Directional Shot -- Shots fire in three directions forward.



4-Directional Shot -- Shots fire on all sides; good for shooting enemies behind you.



Penetrating Shots -- Shots that go through enemies.



Guided Shots -- Shots that aim themselves at the enemy.

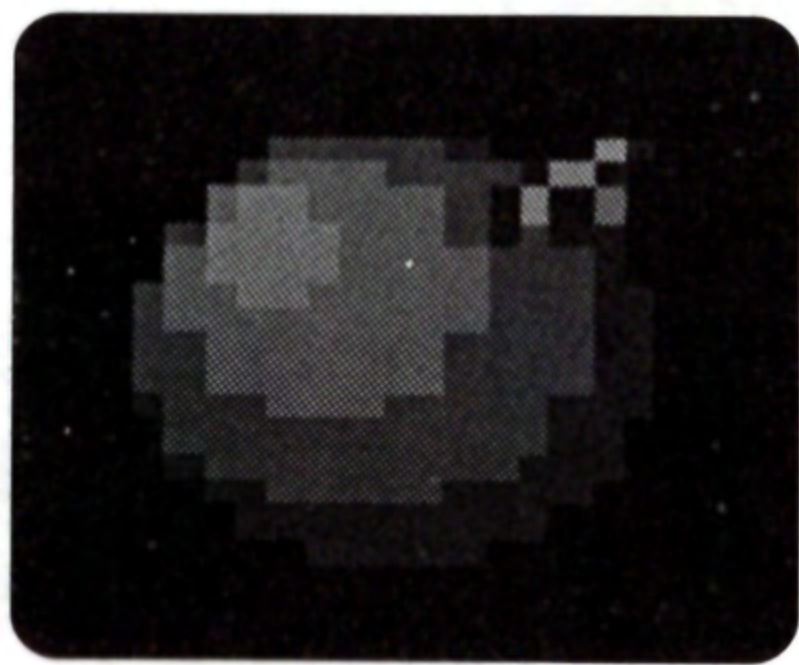

Bombs -- So powerful that even the residual smoke is deadly.

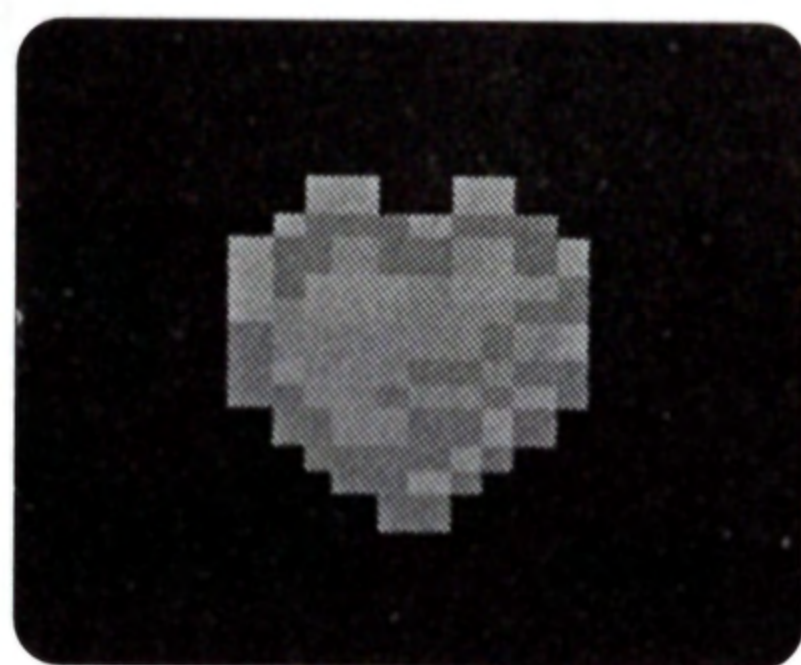

Heart-Shaped Bowl -- Increases the maximum life level.

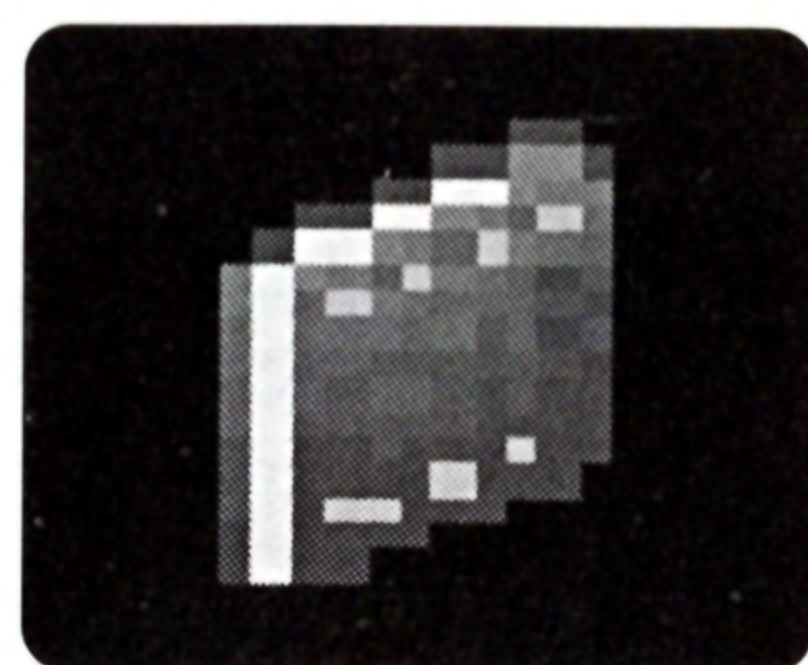

Magic Book -- Increases the maximum Magic Power level.

NAMCO'S TIP LINE

ALL THE HINTS, TRICKS AND CHEATS!!
UNDER 18, PLEASE HAVE YOUR PARENTS
PERMISSION. TOUCHTONE PHONES ONLY.

1-900-737-2262

\$.95/MIN FOR AUTOMATED TIPS
\$1.15/MIN FOR LIVE COUNSELING
9-5 M-F PACIFIC TIME

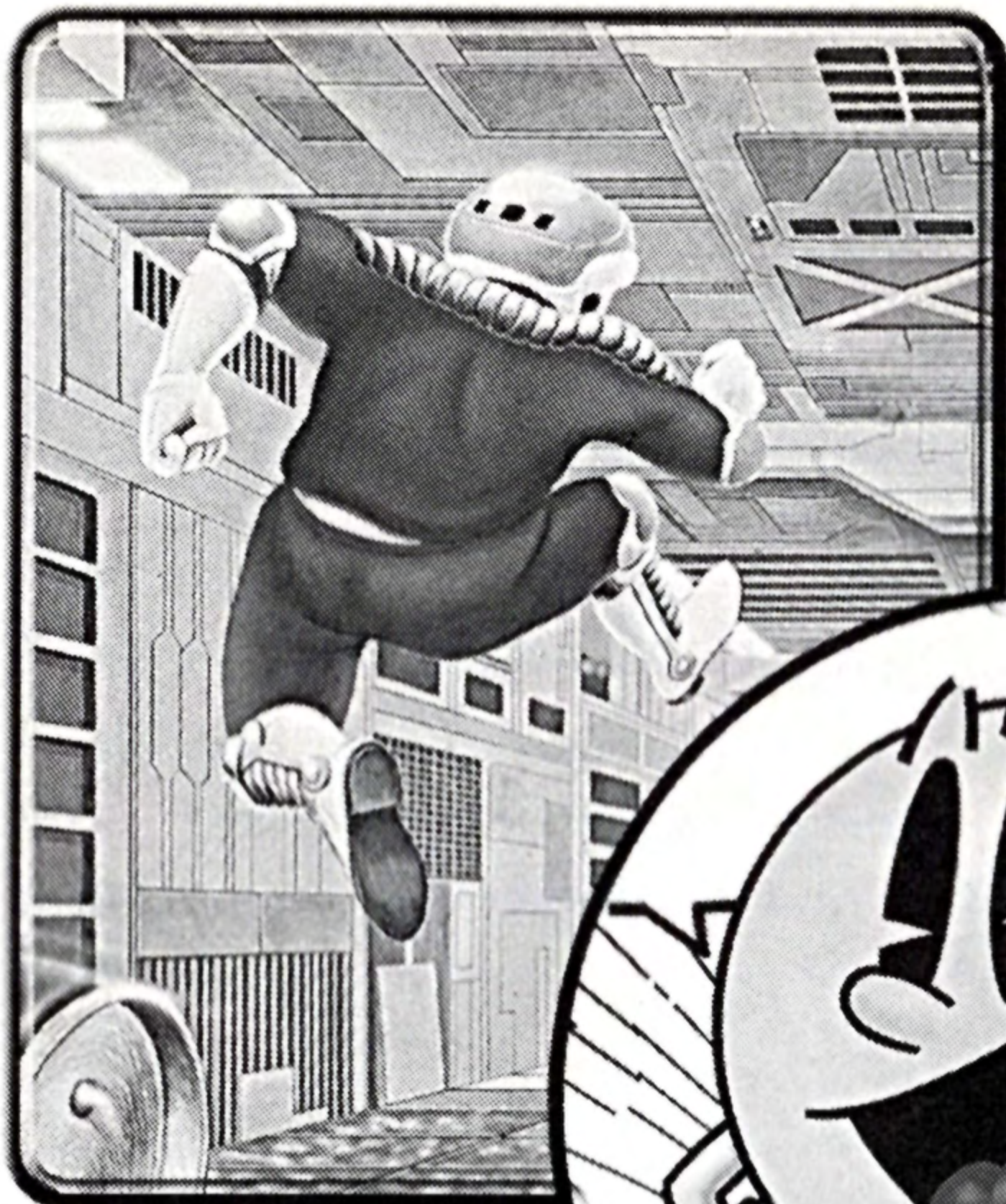

CREDITS

Published by: Namco Hometek Inc.
Designed and Developed by: Namco Ltd.

Namco Hometek Inc. Staff:

MARKETING

Mike Fischer

Loan Vu

Jennifer Fitzsimmons

TECHNICAL EDITORS & MANUAL DEVELOPMENT

Dave Winstead

Scott Rogers

Geoff Erickson

MANUAL DESIGN

Darien & Kilburg

For questions and information
not listed on the 900 line, write to:
Namco Hometek Inc.
150 Charcot Avenue, Suite A
San Jose, CA 95131-1102

Namco Online: <http://www.namco.com>
Visit our Website to get information about our
new titles.

LIMITED WARRANTY

Namco Hometek Inc. warrants to the original purchaser that this Namco Hometek Inc. game pak shall be free from defects in material and workmanship for a period of ninety (90) days from the date of purchase. If a defect covered by this limited warranty occurs during this 90-day limited warranty period, Namco Hometek Inc. will repair or replace the defective game pak or component part, at its option, free of charge.

This limited warranty does not apply if the defects have been caused by negligence, accident, unreasonable use, modification, tampering, or any other cause not related to defective material or workmanship.

LIMITATIONS ON WARRANTY

Any applicable implied warranties of merchantability and fitness for a particular purpose, are hereby limited to ninety (90) days from the date of purchase and are subject to the conditions set forth herein. In no event shall Namco Hometek Inc. be liable for consequential or incidental damages resulting from the possession or use of this product.

The provisions of the limited warranty are valid in the United States only. Some states do not allow limitations on how long an implied warranty lasts, or exclusion of consequential or incidental damages, so the above limitation or exclusion may not apply to you. This limited warranty provides you with specific legal rights. You may have other rights which vary from state to state.



PAPA PAPA

METRO-CROSS

**THE LEGEND
OF
"VALKYRIE"**



Namco Hometek Inc. 150 Charcot Ave., Suite A, San Jose, CA 95131-1102
Namco Museum™ Volume 5 © 1997 Namco Ltd. All Rights Reserved. Manufactured pursuant to license
with Namco Holding Corp.

namco®



Licensed by Sony Computer Entertainment America for use with the PlayStation game console. PlayStation and the PlayStation logos are trademarks of Sony Computer Entertainment Inc. The ratings icon is a trademark of the Interactive Digital Software Association. Manufactured and printed in the U.S.A. THIS SOFTWARE IS COMPATIBLE WITH PLAYSTATION GAME CONSOLES WITH THE NTSC U/C DESIGNATION. U.S. AND FOREIGN PATENTS PENDING.